

Data Sheet



Article number: 2314451463

Description: E+G Cast iron wheel 451463
RE.F4-150-PSL-H - Fixed plate

Measures

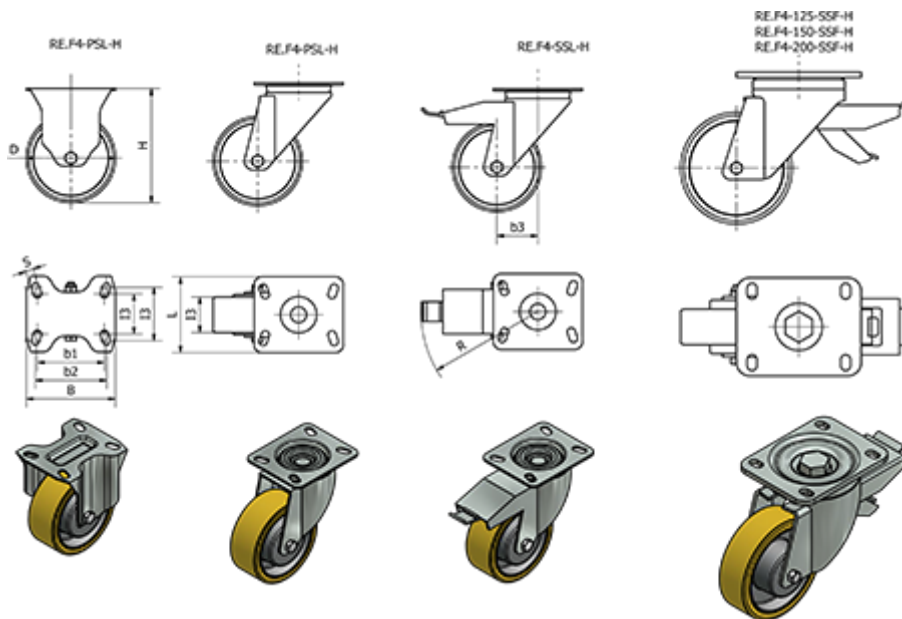

B	= 140	I1	= 73
b1	= 105	I2	= 87
b2	= -	I3	= 50
b3	= 70	L	= 110
Code	= 451463	R	= 126
D	= 150	Rolling resistance (N)	= 2900
Dynamic carrying capacity (N)	= -	s	= 11
H	= 200	Type	= RE.F4-150-PSL-H

weight (g) = 4810